

KITCHENS
FOR OUTDOOR LIVING

DETAILS



BURNOUT **LUX**

LUXURY AND DURABILITY COMBINED

A BURNOUT**LUX** Outdoor Kitchen has one major job: to meet the most demanding requirements. That is why it combines award-winning design with unsurpassed workmanship. Perfectly planned and crafted, down to the smallest detail. Design, production, quality, and reliability – completely made in Germany and awarded the 2022 Red Dot Award.

Outstanding craftsmanship, technical brilliance, and proven durability make BURNOUT**LUX** Outdoor Kitchens a unique, inspired choice. And every customized, individual solution reveals the BURNOUT**LUX**'s unparalleled level of perfection.

Scan the QR code below and configure your own BURNOUT**LUX** Outdoor Kitchen today.

We're happy to answer your questions:

E-Mail: contact@burnout.kitchen

Telephone: **+49 5402 402 491-0**



QR Code for our configurator

CONTENTS

01	Sample Kitchens Everything at a glance Small Mid-sized Large
02	Basic Elements Cabinetry Cabinets and corner cabinets Countertops
03	Grills and Stovetops Bull Flammkraft Fire Magic Burnout Bofun
04	Refrigeration Standalone refrigerators Drawer refrigerators Ice Bucket
05	Utilities Lighting Electricity Supply Water connections
06	Furnishings for Dining Bar counters and integrated tables Single tables and seating
07	Good to Know Quality and design Certifications Production

01 | SAMPLE KITCHENS

Everything at a glance

Small

Mid-sized

Large



EVERYTHING AT A GLANCE

T-Bar counter

For freestanding kitchens

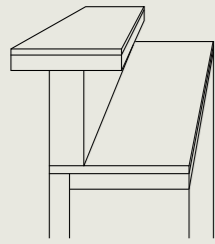

L-Bar counter

For wall-mounted kitchens

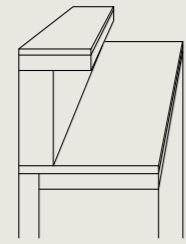

Bar counter options

Available in two designs

Drawer refrigerators

With variable temperature zones

Outlets

Can be placed anywhere along the bar

Integrated grill

Various grill models available

Burnout Flame

With dedicated space for propane tank

Sink from Franke

With drawer underneath

Cabinets with drawers

Available in three different widths: 300 mm, 600 mm, 1200 mm

Stovetop

Induction or gas

Integrated counter table

At bar counter level

Drawer

With dedicated space for propane tank

Caso BBQ Cooler Lux

At bar counter or kitchen counter level

Plinth / Toe kick

To conceal adjustable feet

Corner cabinet

With drawer

Integrated kitchen table

At kitchen counter level

Veneer panels

For rear surfaces as well



Modular



Weatherproof



Limited lifetime warranty



Made in Germany



Adjustable feet



Lighting

SMALL.

BUT WITH HUGE RESULTS.

Not much space? No problem! With BURNOUTLUX, a few square meters are enough for exceptional grilling experiences. Modular construction, clever storage areas – a focus on the essentials.

- Available with connections for propane or natural gas
- 230 V power connection

Top view

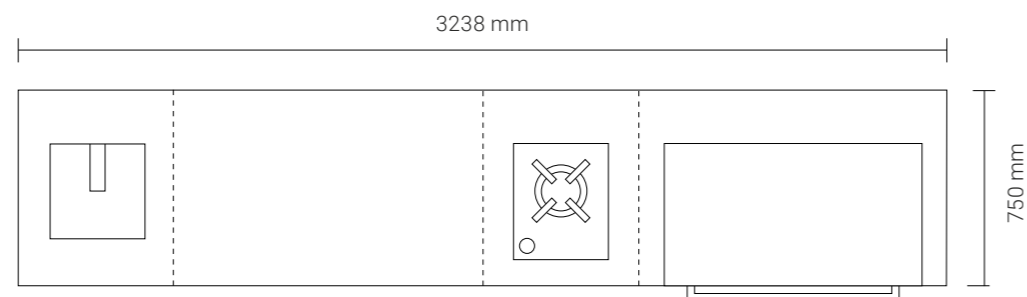

1 Cabinet with sink & drawer
600 mm W x 920 – 990 mm* H x 750 mm D

2 Cabinet with drawer refrigerator
950 mm W x 920 – 990 mm* H x 750 mm D

3 Cabinet with space for propane tank & Bofun Module 400
600 mm W x 920 – 990 mm* H x 750 mm D

4 Flammkraft-D with drawer
1088 mm W x 920 – 990 mm* H x 750 mm D

* Incl. base dimensions (150 – 220 mm)



Note: BURNOUTLUX Outdoor Kitchens are available in four different colors.

We recommend using Dawn and Shadow in relatively well-shaded areas, as intensive solar radiation may cause the surfaces to become hot.



Front view



MID-SIZED.
THE PERFECT SIZE.

The golden mean for plenty of options and plenty of storage.
 A long, straight line, or a clever corner? With refrigerator and sink?
 A cabinet that fits in the corner? All these options are possible.

- Available with connections for propane or natural gas
- 230 V power connection

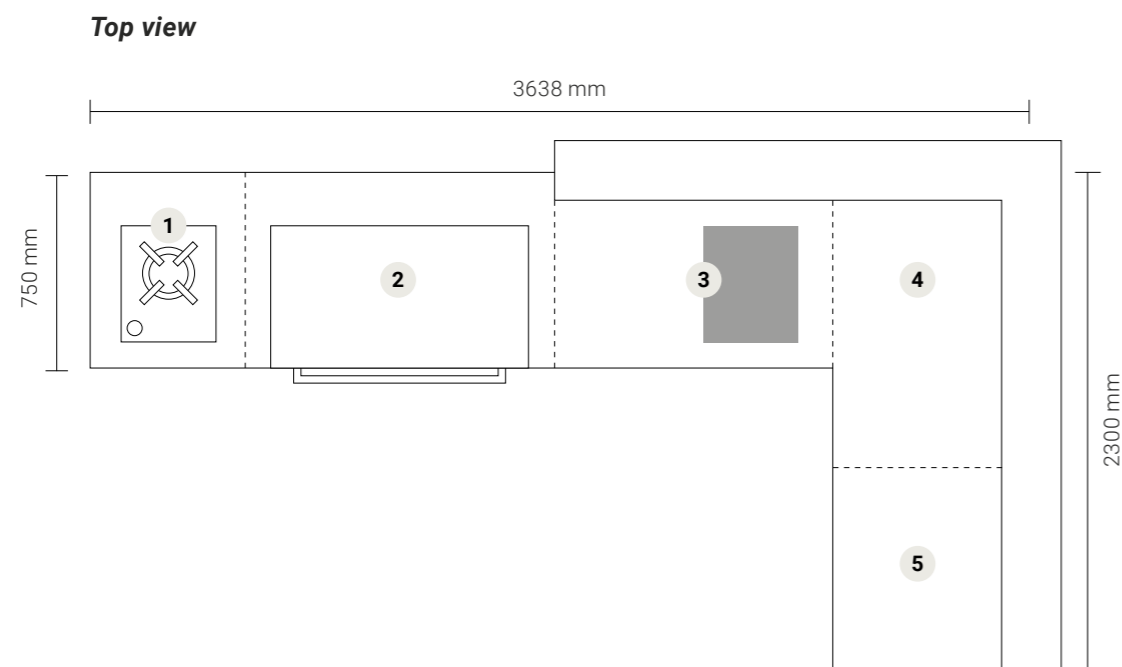

1 Cabinet with space for propane tank & Bofun Module 400
 600 mm W x 920 – 990 mm* H x 750 mm D

2 Flammkraft-D with drawer
 1088 mm W x 920 – 990 mm* H x 750 mm D

3 Cabinet with left drawer & Burnout stovetop on the right
 1200 mm W x 920 – 990 mm* H x 750 mm D

4 Corner cabinet on the left & drawer on the right
 1350 mm W x 920 – 990 mm* H x 750 mm D

5 Cabinet with drawer refrigerator
 950 mm W x 920 – 990 mm* H x 750 mm D

* Incl. base dimensions (150 – 220 mm)

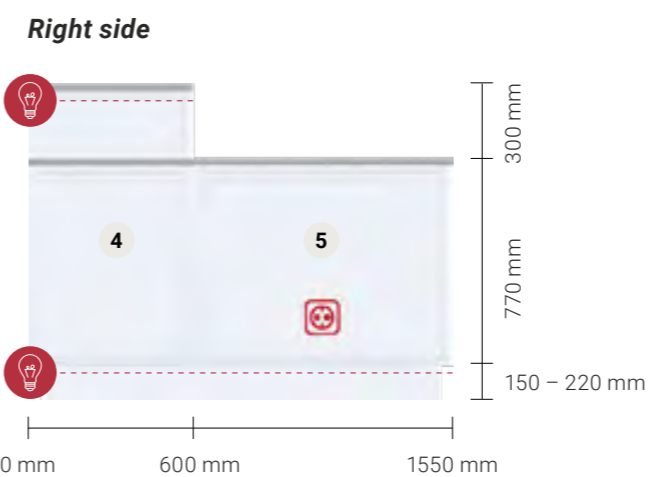

LARGE.

WITH SPACE TO ENJOY THE MOMENT.

A fully equipped kitchen makes it possible to enjoy true comfort, where every culinary wish can come true – and BURNOUTLUX offers this under a bright blue sky, or under the stars. That is how cooking becomes a true culinary experience – for family, friends, or events.

- Available with connections for propane or natural gas
- 230 V power connection



Top view

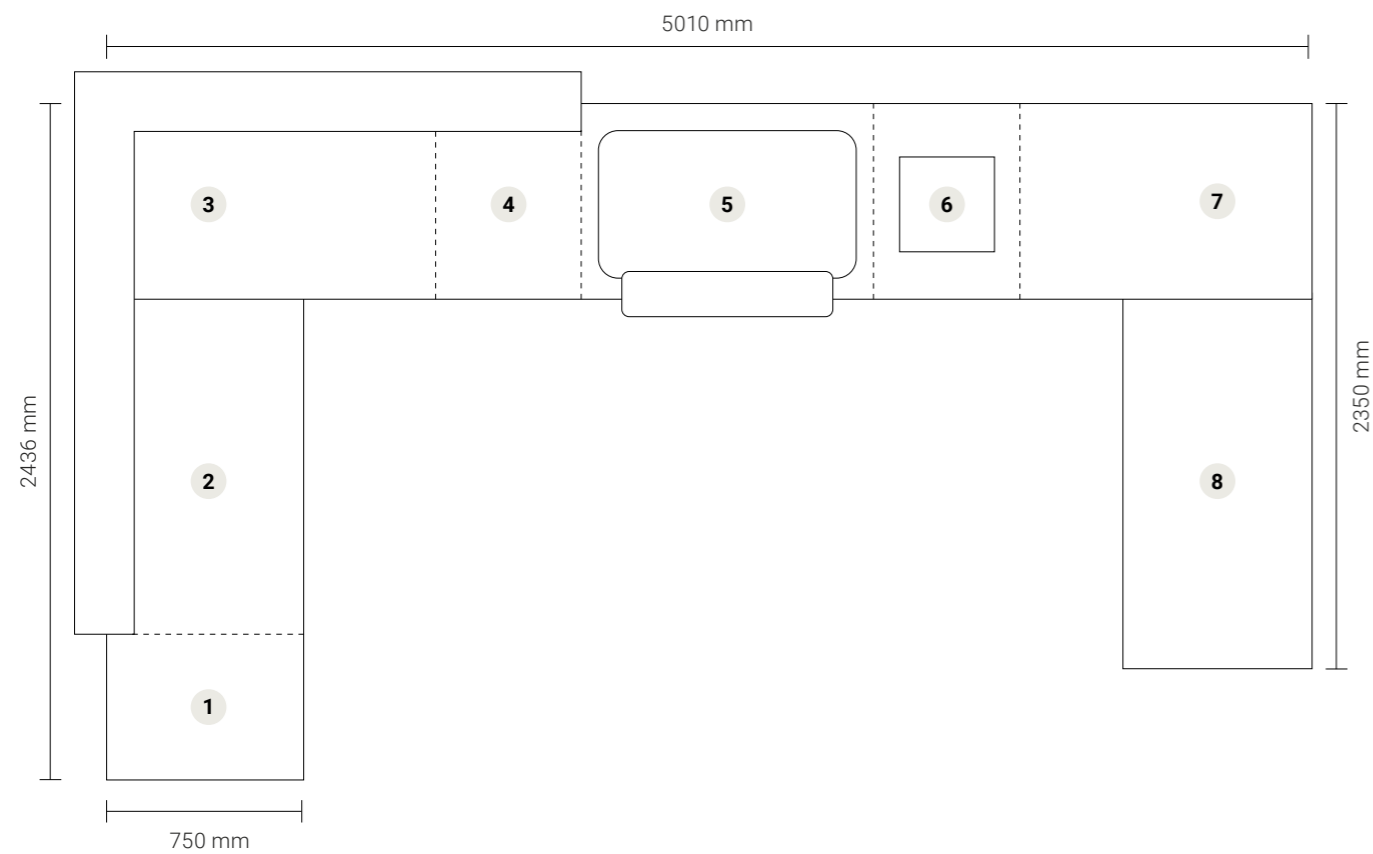

1 Caso BBQ Cooler Medium Lux
486 mm W x 920 – 990 mm* H x 750 mm D

2 Cabinet with two drawers
1200 mm W x 920 – 990 mm* H x 750 mm D

3 Corner cabinet on the left & drawer on the right
1350 mm W x 920 – 990 mm* H x 750 mm D

4 Cabinet with space for propane tank
600 mm W x 920 – 990 mm* H x 750 mm D

5 Fire Magic Echelon E790 with drawer
1200 mm W x 920 – 990 mm* H x 750 mm D

6 Cabinet with drawer, dedicated space for propane tank, and Burnout Flame
600 mm W x 920 – 990 mm* H x 750 mm D

7 Corner cabinet on the right & drawer left
1350 mm W x 920 – 990 mm* H x 750 mm D

8 Integrated kitchen table
1600 mm W x 920 – 990 mm* H x 750 mm D

Front view

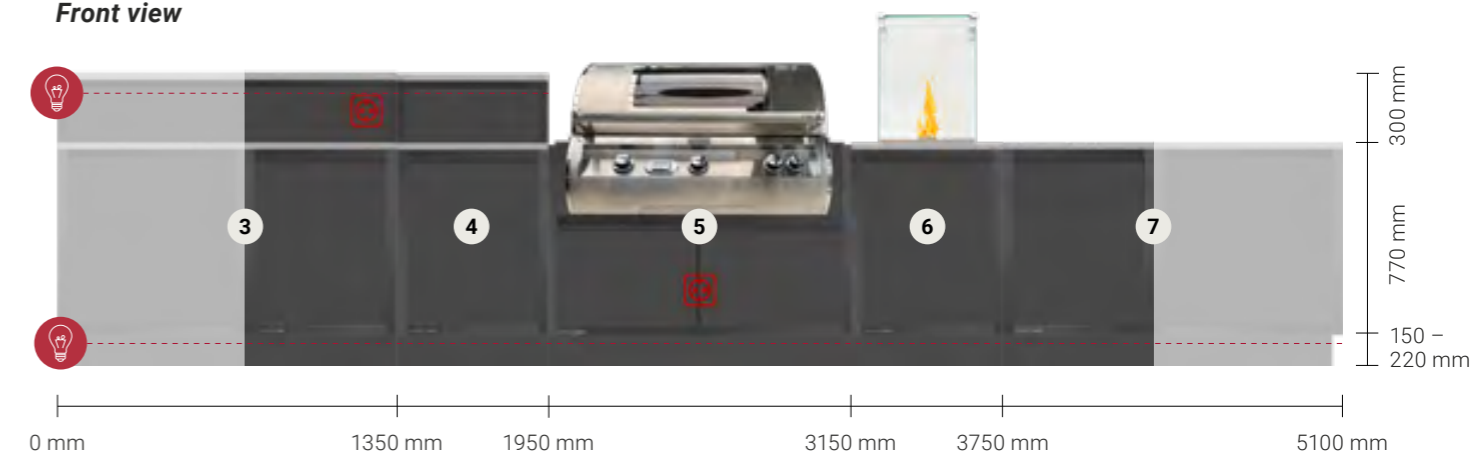

Left side

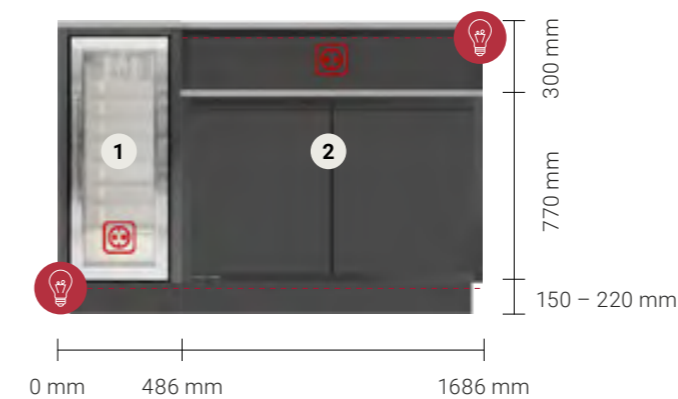

Right side

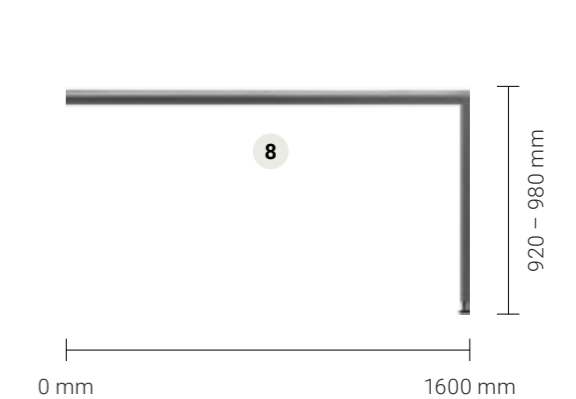

02 | BASIC ELEMENTS

CABINETRY

CABINETS AND CORNER CABINETS

COUNTERTOPS



CABINETS

Elegant. Refined. Sophisticated. With the right color scheme, BURNOUTLUX Outdoor Kitchens are a perfect fit for a life worth savoring. Inspired by nature, the BURNOUTLUX palette complements and accentuates the surrounding environment, creating the optimal fit for every setting: chalk cliffs or summer clouds – the “Pure” palette brings the necessary lightness. “Dust” evokes the pristine feeling of the beaches of the South Pacific. and “Dawn” and “Shadow” reflect a sophisticated reserve.



Note: BURNOUTLUX Outdoor Kitchens are available in four different colors. We recommend using Dawn and Shadow in relatively well-shaded areas, as intensive solar radiation may cause the surfaces to become hot.

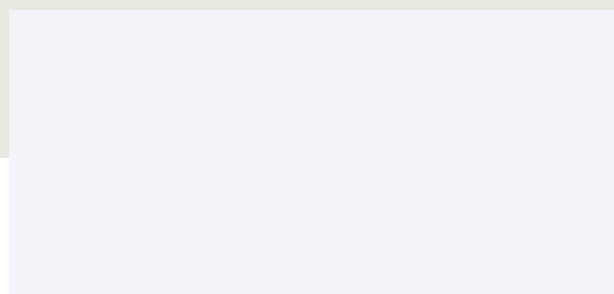

Pure

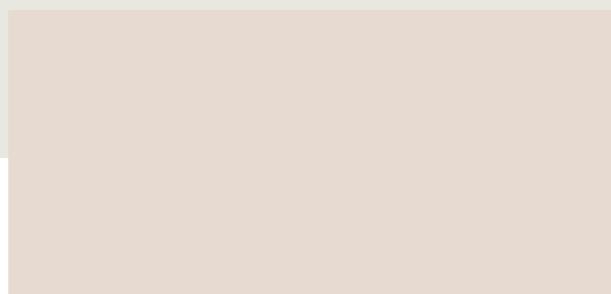

Dust

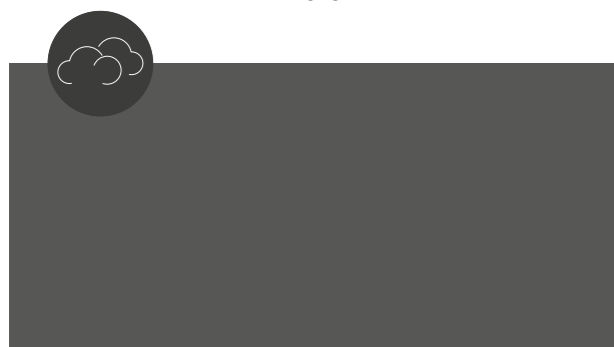

Dawn



Shadow



Panels & Plinth / Toe kick

Polymer cabinetry parts

Frames

Made of powder-coated stainless steel

Fittings

Certified for outdoors



Limited Lifetime warranty

Materials

Burnout Outdoor Kitchens are designed for outside use. Made of high-quality stainless steel and weatherproof, UV-resistant materials and fittings certified for outdoor use. Built to last: at least 10 years. Guaranteed (Limited Lifetime warranty).

Plinth / Toe kick

- The polymer material used for the panels is also used for the plinth/toe kick.
- The plinth/toe kick can be modified on site with common carpentry tools (jigsaws, circle saws, drills, etc.) to trim to the necessary height.
- The plinth/toe kick can also be removed and opened at any time, for example to clean underneath the cabinetry.

CABINETS

With designer fittings its elegant and its elegant front panels, cabinetry is a key design element in BURNOUTLUX Outdoor Kitchens. Its depth allows ample storage, and its convenient inserts for silverware and utensils mean that the necessary things are always close at hand. This makes the cooking experience even more enjoyable.

- Large drawer for storage
- Upper drawer for silverware and other smaller utensils
- 750 mm deep

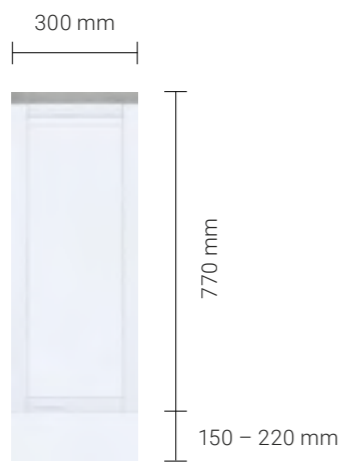

With drawer

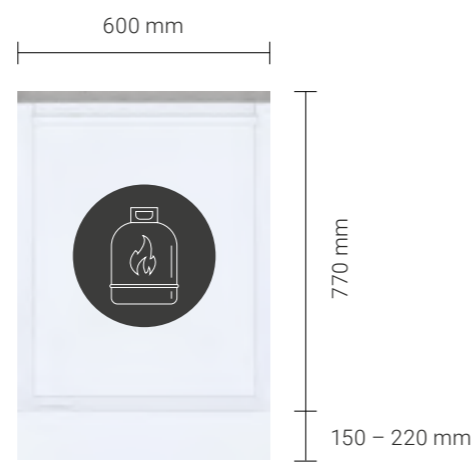

With drawer or propane-tank storage



With propane-tank storage and flame

Heat output von 6.5 – 9 kW and powered by propane or natural gas



With drawer and sink

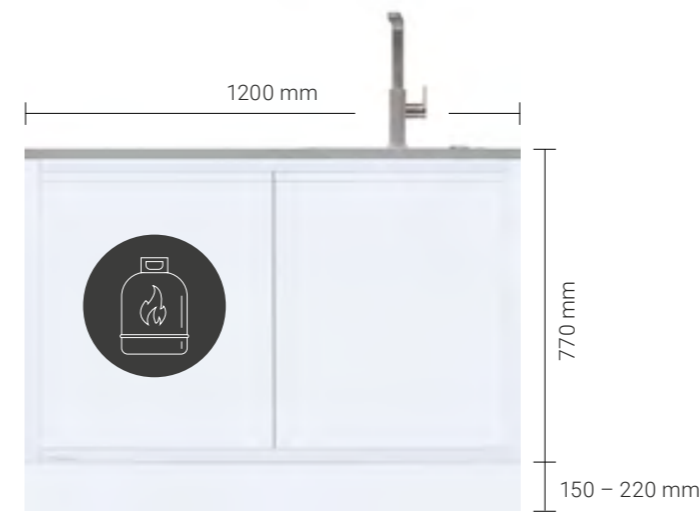

With sink and propane-tank storage

Customizable placement

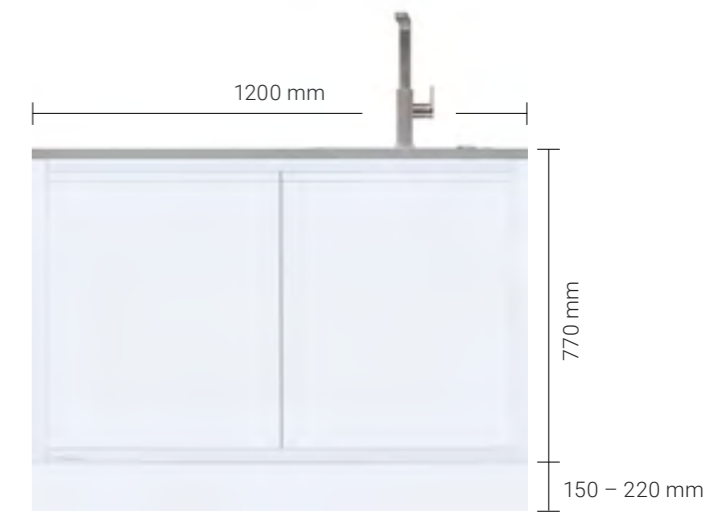

With sink and drawer

Customizable placement

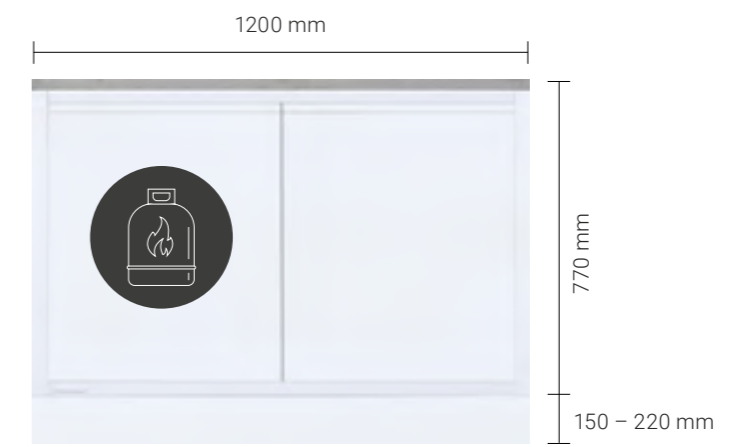

With propane-tank storage and drawer

Customizable placement

CORNER CABINETS

- One large drawer, one silverware drawer
- The corner area (750 x 750 mm) is not usable as storage space (a passive ice bucket in the corner part of the countertop is an available option)

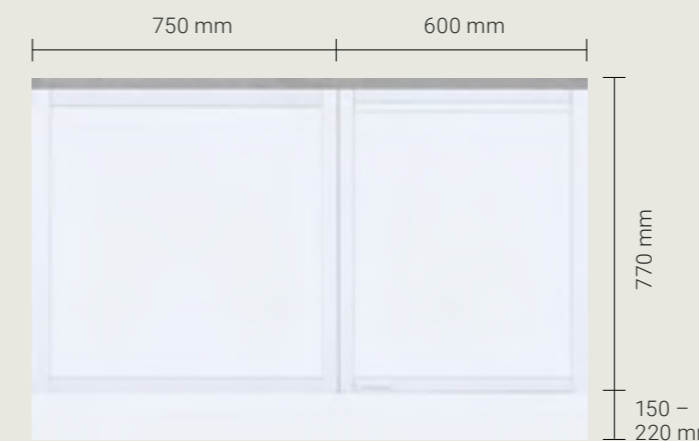

Corner cabinet

Corner left / drawers right



Corner cabinet

Drawers left / corner right

INSERTS AND STORAGE

Drawer dividers / organizers

- Freely and easily adjustable
- Included as standard features

Silverware organizers

- Included as standard features

Storage system for propane tanks

The energy supply for propane burners is conveniently and safely close at hand. There is dedicated space for the propane tank, and our clever solutions make exchanging it quick and easy.

- Dedicated drawer for propane tank
- Sufficient space for propane tank
- Stored in a secure stainless-steel frame
- Convenient storage system for easy tank exchange



Drawer dividers / organizers



Silverware organizers



Storage system for propane tanks

DEKTON® COUNTERTOPS

The technical, ultracompact stone. Dekton is a sophisticated blend of 20 natural minerals. It is inspiring the future of architecture and design, in which living spaces take on an atmosphere where that beauty and functionality coexist in perfect synergy.

Highlights:

- Abrasion resistant
- Scratch and impact resistant (7/10 on the Mohs Scale)
- Water and stain resistant
- Easy to clean with standard cleaning products

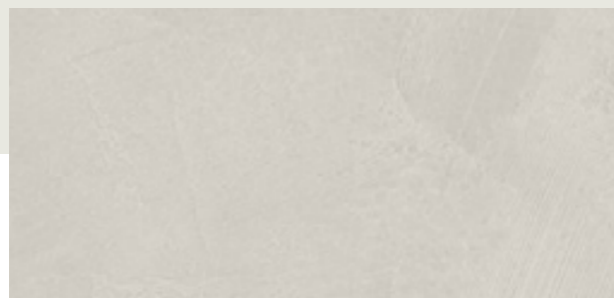

Sandgrey



Grey

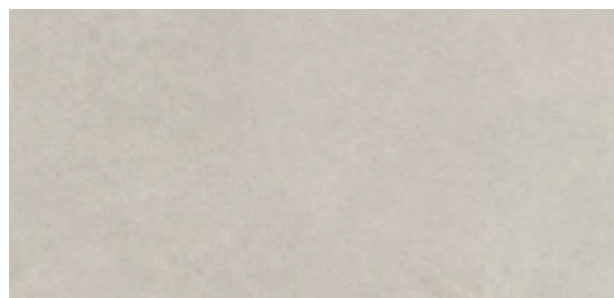

Light Grey

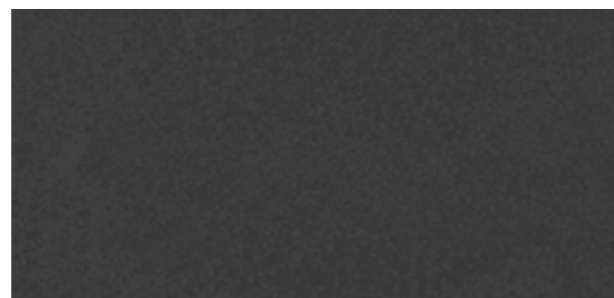

Dark Grey

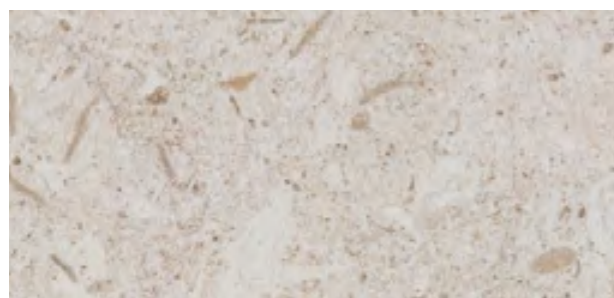

Travertine

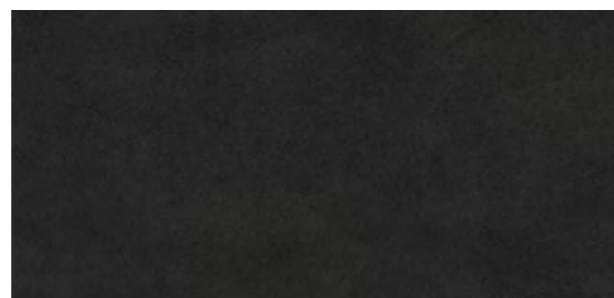

Black



End panels / Side panels and beveled edges

- Bevels increase durability
- Protection against chipping



**03 | GRILLS AND
STOVETOPS**

BULL

FLAMMKRAFT

FIRE MAGIC

BURNOUT

BOFUN



BULL

Strong, stable, and packed with power: The powerful Bull Angus Grill delivers on its promises. With four high-performance burners, it cooks steaks to perfection, as well as grilling vegetables or delicate seafood. The rear burner with rotisserie ensures the perfect roast – catering to every taste. Crafted with high-end quality and extreme durability.

- The classic BBQ grill
- Stainless steel construction
- Cast stainless steel burners
- Integrated rear burner
- Available for propane or natural gas
- 230 V power connection



BULL Brahma with drawer

Total grill area	970 mm x 490 mm
Warming grate	970 mm x 180 mm
Module width	1061 mm
Total output	26.4 kW
Burners	5 tube burners + 1 Infrared rear burner
Accessories	Rotisserie and Lighting



BULL Angus with drawer

Total grill area	760 mm x 490 mm
Warming grate	760 mm x 180 mm
Module width	871 mm
Total output	22 kW
Burners	4 tube burners + 1 Infrared rear burner
Accessories	Rotisserie and Lighting



BULL Sideburner with drawer

Total grill area	337 mm x 632 mm
Warming grate	Not available
Module width	385 mm
Total output	7 kW
Burners	2 tube burners



FLAMMKRAFT

Power for BBQ enthusiasts: The Flammkraft gas grill is not only stylish but also crafted with extremely high quality, ensuring genuine grilling pleasure. Whether you need high heat for steaks or ribs, or a gentler roast for grilling vegetables, Flammkraft offers precisely the right temperature zone and plenty of space.

- Made in Germany
- Suitable for grilling and roasting
- Roasting zone and 2 high-powered gas burners
- 2 indirect and 1 direct infrared burners
- No electricity necessary
- For propane or natural gas
- Height of grill approx. 940 mm
- Grill grate made from cast stainless steel



Set into the countertop



Set in stainless steel



Flammkraft-D with drawer

Total grill area	900 mm x 440 mm
Module width	1088 mm
Weight	Approx. 130 kg
Total output	16.2 kW
Temperature	75°C bis 900°C



Flammkraft-C with drawer

Total grill area	750 mm x 400 mm
Module width	938 mm
Weight	Approx. 80 kg
Total output	12.5 kW
Temperature	100°C bis 900 °C



FIRE MAGIC

Promising magical grilling moments: This high-class gas grill enchants with its power, premium craftsmanship, and immense versatility. The additional integrated rear burner, equipped with a stainless steel rotisserie spit, offers the finest rotisserie cooking. With the digital thermometer and the warming rack, achieving precise cooking is made easy, resulting in the most tender grilling experience.

- Integrated rear burner
- Top-quality workmanship
- Window in the grill cover
- Made in the USA
- For propane or natural gas
- Digital thermometer on the control panel

MADE IN
USA



Fire Magic E790 with drawer

Total grill area	914 mm x 559 mm
Warming grate	914 mm x 203 mm
Module width	1200 mm
Total output	Main burner: 26.4 kW Rear burner: 3.8 kW
Burners	3 cast stainless-steel main burners + 1 rear burner
Accessories	Rotisserie



Fire Magic E1060 with drawer

Total grill area	1219 mm x 559 mm
Warming grate	1219 mm x 203 mm
Module width	1530 mm
Total output	Main burner: 32.8 kW Rear burner: 6.4 kW
Burners	4 cast stainless-steel main burners + 1 rear burner
Accessories	Rotisserie



Fire Magic Echelon Double-Side Burner with drawer

Module width	600 mm
Warming grate	Not available
Total output	9 kW
Accessories	2 Burners



BURNOUT INDUCTION STOVETOP

Professional chefs swear by induction technology on the stove: It's easy to precisely adjust temperatures, heat food up in an instant – and energy efficient at the same time. The Burnout Induction Stovetop brings this technology outdoors as well – the perfect complement to the grill.

- 2 independently controllable induction zones
- Illuminated control panel
- High-quality glass cooking surface
- 230 V power connection
- 2.8 kW total output

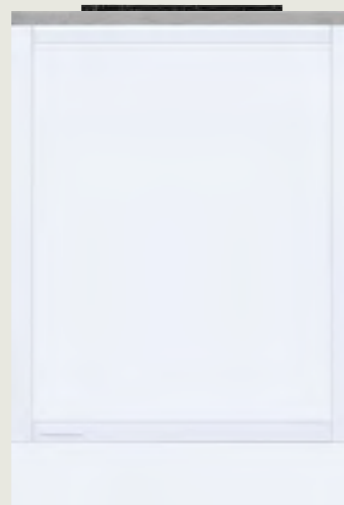

BOFUN MODULE 400

The new high-performance gas burner module from Bofun creates unique culinary experiences. Its powerful burner has justifiably earned the prestigious Red Dot Award. The Bofun Module 400 is far more than just functionality, awakening passion on every culinary journey.

- Power and speed: The burner reaches a temperature of 300 °C in just 30 seconds.
- Durable design: The 4-mm stainless-steel construction is long-lasting and easy to clean.
- High Output: 14 kW of power ensure an incomparable grilling experience.

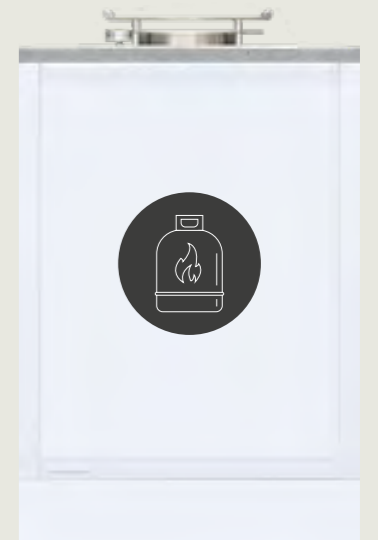

04 | REFRIGERATION

STANDALONE REFRIGERATORS

DRAWER REFRIGERATORS

ICE BUCKET





STANDALONE REFRIGERATORS

Beer, white wine, and prosecco stay cool, even in summer's heat. And the glass door allows every guest to know where to find the perfect cold refreshment.

- Perfect for refrigerating drinks, salads, or food
- 230 V power connection
- Approx. 63 l or 125 l capacity available
- Single temperature zone
- Glass door for a clear overview
- Lighting



Caso BBQ Cooler Lux
At kitchen counter level

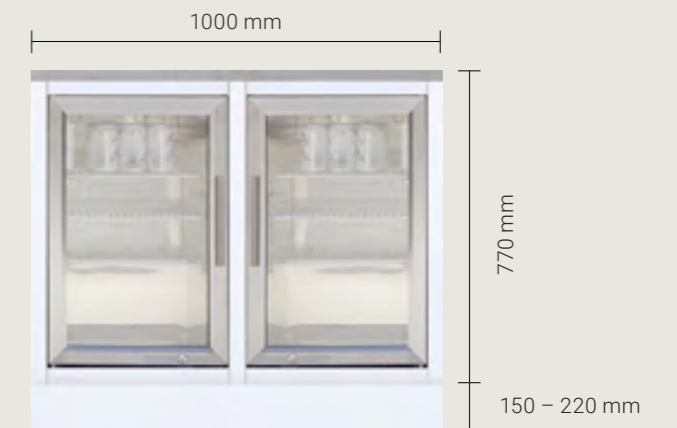

Doppel-Caso BBQ Cooler Lux
At kitchen counter level



Caso BBQ Cooler Medium Lux
At bar counter level

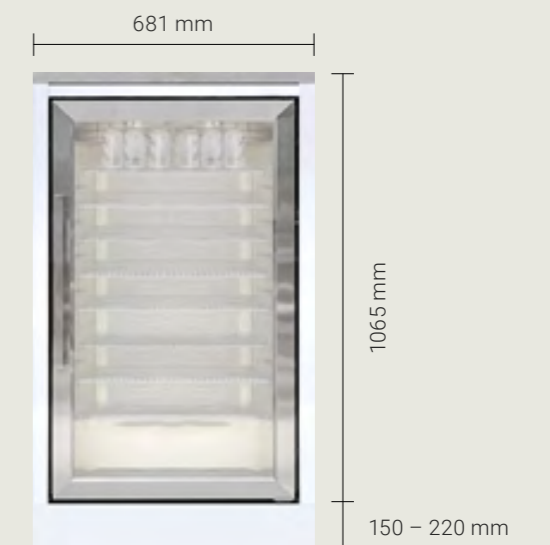

Caso BBQ Cooler Large Lux
At bar counter level



DRAWER REFRIGERATOR

Integrated drawer refrigerators from Fisher & Paykel offer additional storage for food and are the perfect complement to a BURNOUTLUX Outdoor Kitchen. One particular highlight is the variable temperature control. This makes the drawer convenient for various types for food and beverages, such as the clever “chill function” which is ideal for defrosts meat or fish.

- Additional storage space
- Variable temperature control with adjustable cooling zone (from -18° to 15° C)
- Precise temperature maintenance
- Additional freezing options
- 104 l total volume / 80 l useable volume



An ideal solution for unused space (750 x 750 mm) in the corner cabinets



ICE BUCKET

Champagne and open bottles of wine and water need a cool solution so they are quickly available and refreshing even when the heat is on. Et voilà!

05 | UTILITIES

LIGHTING

ELECTRICITY SUPPLY

WATER CONNECTIONS





LIGHTING

FOR PLINTH AND BAR COUNTER

Cleverly positioned lighting and appropriately placed sockets create a powerful visual impact. After all, as we know: food should also be a feast for the eyes.

- ZigBee capable
- Remote control function included
- Dimmable
- Warm white
- IP44 standard



ELECTRICITY SUPPLY

With BURNOUTLUX, you are not only deciding for a perfect Outdoor Kitchen, but also for perfect service. That begins with perfect consultation and planning, followed by on-site measurements, right up to timely delivery and installation.

Service: Our technicians install all electrical components.



Details about Outlets:

- IP68 certified system
- 16 A 250 V~ outlets with hinged covers
- Unbreakable thermoplastic housing
- Waterproof flush-mounted IP44
- Anthracite
- Stable and corrosion-resistant steel flange

Additional Openings in Cabinetry:

If a chase needs to be opened in the rear of the Outdoor Kitchen to install cables or wires, for example, this can be done with common carpentry tools (drills, circle cutters, etc.).



MADE IN GERMANY

FRANKE

WATER CONNECTIONS / SINKS

A water source right next to the fire source: with premium sinks from Franke made of stainless steel, everything can stay clean even during the grilling process. Rinse the lettuce, even clean a plate or two. As convenient as the indoor kitchen – nothing is more practical!

- Top-quality workmanship
- Sink size 500 x 410 x 200 mm
- Stainless steel faucet connected to the main water supply or to an optional drinking-water supply
- Dark sinks for dark kitchens and light sinks for light kitchens

**06 | FURNISHINGS FOR
DINING**

*BAR COUNTERS
AND INTEGRATED TABLES*

SINGLE TABLES AND SEATING



BAR COUNTERS

The great thing about a Burnout Outdoor Kitchen is that it can be expanded at any time. For instance, with optional corner counter elements, providing more practical storage space.

- Convenient storage spaces for glasses or kitchen utensils
- Can be added as a corner extension
- Possibility of lighting and electrification

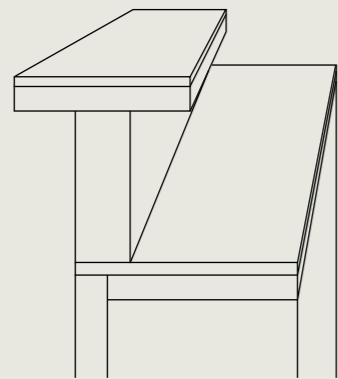

T-Bar counter
For freestanding kitchens

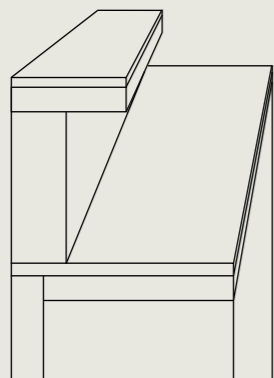

L-Bar counter
For wall-mounted kitchens



INTEGRATED TABLES

Our BURNOUTLUX integrated tables offer the possibility to sit directly in front of the action. They are available at two different levels – at kitchen counter level or bar counter level.

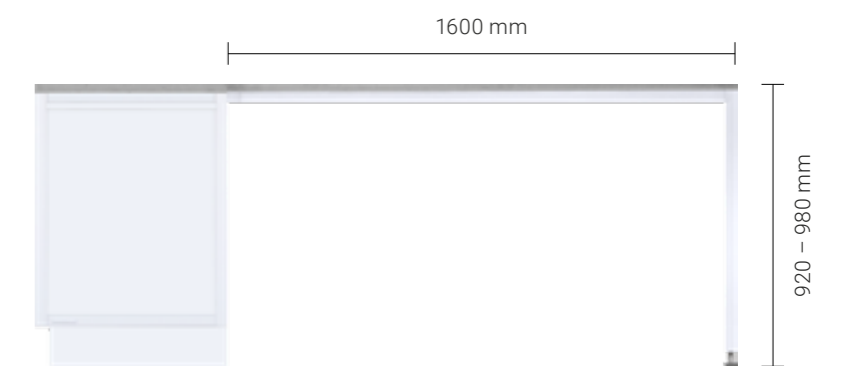

Integrated Kitchen Table
At kitchen counter level

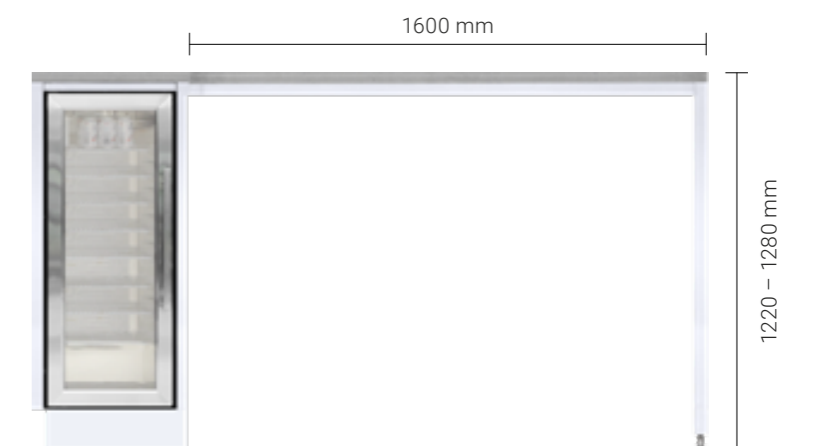

Integrated Counter Table
At bar counter level or above the refrigerator

SINGLE TABLES

Enjoying the good things in life, sharing laughter, celebrations and life. Even the most attractive outdoor kitchen is doubly attractive with the right guests. And because we know how important perfection is when it comes to entertaining, we have designed tables and chairs to match BURNOUT **LUX** Outdoor Kitchens.

Just as elegant in design, perfectly finished, and durable. With a stone top and stainless steel frame, it's made for outdoor living.



Table **LUX L**



Table **LUX XL**

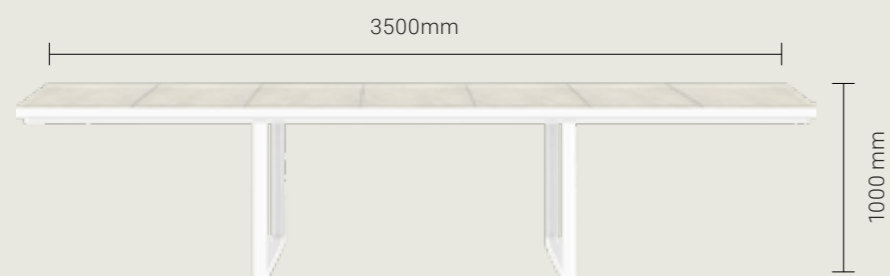

Table **LUX XXL**



Customizable height thanks to adjustable feet



Beveled edges to prevent chipping and damage



SEATING

Take a seat! Comfortable and practical, but no less stylish, our seating options are designed to tastefully add to the design of our kitchens. And obviously they're just as durable outdoors as all of our BURNOUTLUX products.



Counter stool
With backrest / high

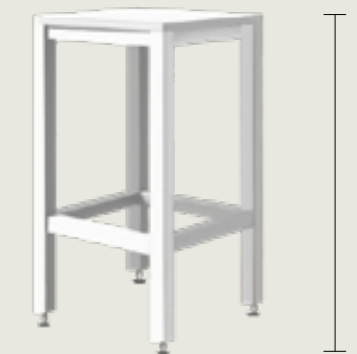

Counter stool
Without backrest / high



Kitchen chair
With backrest / low



Kitchen seats
Without backrest / low

07 | GOOD TO KNOW

QUALITY AND DESIGN

CERTIFICATIONS

PRODUCTION



EXCELLENT CRAFT & DESIGN

MADE IN GERMANY

Compatible

Burnout outdoor kitchens are easily compatible with a variety of grill and hotplate manufacturers. That's clear. Still, our top priorities are functionality, craftsmanship, and design. Which is why we are happy to recommend partners who meet our requirements – like Flammkraft, BULL, or Fire Magic, for example.

Weatherproof

Burnout outdoor kitchens are built for the outdoors. Made of high-quality stainless steel, weather-resistant and UV-resistant materials, and hardware certified for outdoor use. So they last: At least ten years. Guaranteed. (Limited Lifetime warranty).

Made in Germany

The craftsmanship of Burnout outdoor kitchens is unparalleled. And come pre-assembled from our own manufacturing plant in Germany. With precision in every cut. Perfection in every weld. Exactness in every seam. For more enjoyment and greater durability.

Modular

Burnout outdoor kitchens can be modified as your needs evolve. One way today. Another way tomorrow. That won't change: our outdoor kitchens are modular and therefore can always be adapted to new wishes. Even years from now, you will be able to expand it without any alterations in the colour scheme.

Sustainable

Burnout outdoor kitchens are extremely durable. And at the same time, they are fully recyclable at the end of their life. Because withstanding wind and weather does not mean being limited to using PVC. Quite the opposite: we only use PVC-free materials to build our kitchens.



reddot winner 2022



CERTIFICATIONS





PRODUCTION

HANDMADE WITH THE BEST, BY THE BEST

We take things personally – and we like it that way. Because each of our outdoor kitchens is unique, and tailored to your individual needs. And to make sure that we are able to put our hands in the fire for each of our outdoor kitchens, we manufacture them with all the attention to detail and quality found in Good Old Germany.

To be precise, in Bissendorf at our "Manustrie" – as we like to call it. It is a combination of the German words Manufaktur (handcrafted production) and Industrie (robot-supported industrial production). This allows us the best of both worlds, for every step of the production process. Because this is the only way to combine our passion for fire and flame and give it the freedom it needs: meticulous, industrial precision combined with the finest craftsmanship by our highly trained, attentive specialists.

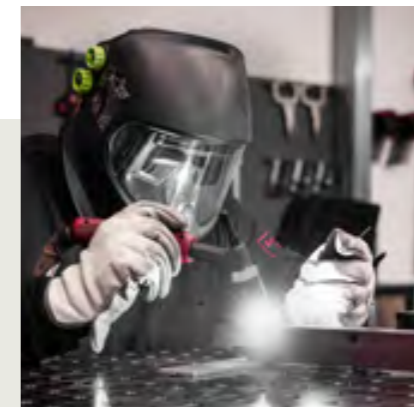

BURNOUT**LUX**

GEWERBEPARK 9-11
49143 BISSENDORF
GERMANY

WWW.BURNOUT.KITCHEN

